

Product Summary

$V_{DS} = 1200\text{ V}$
 $I_D@25^\circ\text{C} = 69\text{ A}$
 $R_{DS(ON)} = 33\text{ m}\Omega$

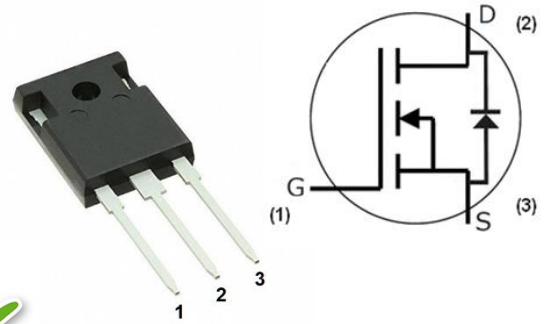

TO-247-3

Features

- High Blocking Voltage
- High Frequency Operation
- Low on-resistance
- Fast intrinsic diode with low reverse recovery
- 100% avalanche tested

Benefits

- Higher System Efficiency
- Parallel Device Convenience without thermal runaway
- High Temperature Application
- Hard Switching & Higher Reliability
- Easy to drive

Applications

- Motor Drives
- Solar / Wind Inverters
- EV Charging Station
- AC/DC converters
- DC/DC converters
- Uninterruptable power supplies

Maximum Ratings ($T_C=25^\circ\text{C}$ unless otherwise specified)

Symbol	Parameter	Value	Unit
V_{DSmax}	Drain - Source Voltage	1200	V
V_{GSmax}	Gate - Source Voltage (dynamic), $T_{surge} < 100\text{ns}$	-10 / +25	V
V_{GSop}	Gate - Source Voltage (static)	-5 / +20	V
I_D	Continuous Drain Current	$V_{GS} = 20\text{V}, T_C=25^\circ\text{C}$	69
		$V_{GS} = 20\text{V}, T_C=100^\circ\text{C}$	49
$I_{D(pulse)}$	Pulsed Drain Current at $T_C=25^\circ\text{C}$	114	A
E_{AS}	Avalanche Energy	576	mJ
I_{AV}	Avalanche Peak Current	24	A
P_D	Total power dissipation	330	W
T_J	Operating Junction Temperature	-55 to 175	$^\circ\text{C}$
T_{STG}	Storage Temperature	-55 to 175	$^\circ\text{C}$

Stresses exceeding those listed in the Maximum Ratings table may damage the device. If any of these limits are exceeded, device functionality should not be assumed, damage may occur and reliability may be affected.

Electrical Characteristics ($T_C=25^\circ\text{C}$ unless otherwise specified)

Parameter	Symbol	Test conditions	Min	Typ	Max	Unit
Drain-Source Breakdown Voltage	$V_{(BR)DSS}$	$V_{GS} = 0V, I_D = 100\mu A$	1200			V
Gate Threshold Voltage	$V_{GS(th)}$	$V_{DS} = V_{GS}, I_D = 10mA$	1.8	2.6	3.5	V
		$V_{DS} = V_{GS}, I_D = 10mA, T_J = 150^\circ\text{C}$		1.9		
		$V_{DS} = V_{GS}, I_D = 10mA, T_J = 175^\circ\text{C}$		1.8		
Zero Gate Voltage Drain Current	I_{DSS}	$V_{DS} = 1200V, V_{GS} = 0V$	0	1	50	μA
Gate-Source Leakage Current	I_{GSS}	$V_{GS} = 20V, V_{DS} = 0V$	0	1	200	nA
Gate-Source Leakage Current	I_{GSS}	$V_{GS} = -5V, V_{DS} = 0V$	-200	-1	0	nA
Drain-Source On-State Resistance	$R_{DS(on)}$	$V_{GS} = 20V, I_D = 40 A$		33	44	m Ω
		$V_{GS} = 20V, I_D = 40 A, T_J = 150^\circ\text{C}$		51		
		$V_{GS} = 20V, I_D = 40 A, T_J = 175^\circ\text{C}$		58		
Transconductance	g_{fs}	$V_{DS} = 20V, I_D = 40 A,$		26		S
		$V_{DS} = 20V, I_D = 40 A, T_J = 150^\circ\text{C}$		23		
		$V_{DS} = 20V, I_D = 40 A, T_J = 175^\circ\text{C}$		22		
Input capacitance	C_{iss}	$V_{DS} = 1000V, V_{GS} = 0V$ $f = 1MHz$		2660		pF
Output capacitance	C_{oss}			128		
Reverse transfer capacitance	C_{rss}			9		
C_{oss} Stored Energy	E_{oss}			84		
Total gate charge	Q_g	$V_{DS} = 800V, V_{GS} = -5V / 20V$ $I_D = 40 A,$		135		nC
Gate-source charge	Q_{gs}			36		
Gate-drain charge	Q_{gd}			53		
Internal gate input resistance	$R_{g(int)}$	$f = 1MHz, I_D = 0A$		2.5		Ω
Turn-On Switching Energy	E_{ON}	$V_{DS} = 800 V, V_{GS} = -5V/20V,$ $I_D = 40A, R_{G(ext)} = 2\Omega,$ $L = 100\mu H$		1050		μJ
Turn-Off Switching Energy	E_{OFF}			60		
Turn-On Delay Time	$t_{d(on)}$			35		ns
Rise Time	t_r			15		
Turn-Off Delay Time	$t_{d(off)}$			32		
Fall Time	t_f			10		

Reverse Diode Characteristics ($T_C=25^{\circ}\text{C}$ unless otherwise specified)

Parameter	Symbol	Condition	Min	Typ	Max	Unit
Diode Forward Voltage	V_{SD}	$V_{GS} = -5\text{V}, I_{SD} = 20\text{A},$		4.6		V
		$V_{GS} = -5\text{V}, I_{SD} = 20\text{A},$ $T_J = 150^{\circ}\text{C}$		4.1		
		$V_{GS} = -5\text{V}, I_{SD} = 20\text{A},$ $T_J = 175^{\circ}\text{C}$		4.0		
Continuous Diode Forward Current	I_S	$V_{GS} = -5\text{V}$			55	A
Reverse Recovery time	t_{rr}	$V_{GS} = -5\text{V}, I_{SD} = 40\text{A},$ $V_R = 800\text{V}, \text{d}i/\text{d}t = 1700\text{ A}/\mu\text{s}$		45		ns
Reverse Recovery Charge	Q_{rr}			370		nC
Peak Reverse Recovery Current	I_{rrm}			16		A

Thermal Characteristics

Symbol	Parameter	Min	Typ	Max	Unit
$R_{th(j-c)}$	Thermal resistance from junction to case		0.35	0.45	$^{\circ}\text{C}/\text{W}$
$R_{th(j-a)}$	Thermal resistance from junction to ambient		30	40	$^{\circ}\text{C}/\text{W}$

Typical Performance

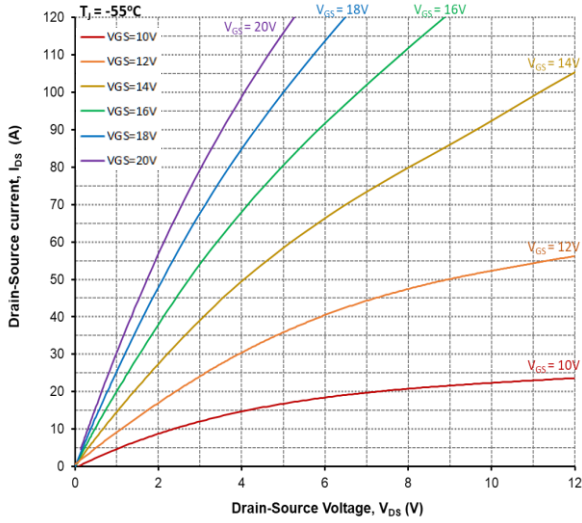

Figure 1. Output Characteristics, $T_J = -55^\circ\text{C}$

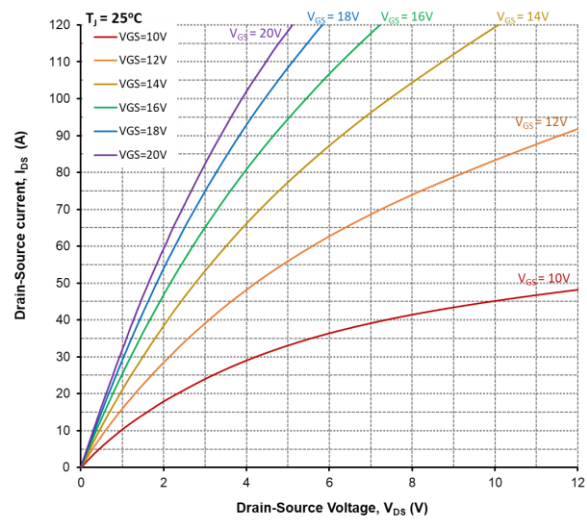

Figure 2. Output Characteristics, $T_J = 25^\circ\text{C}$

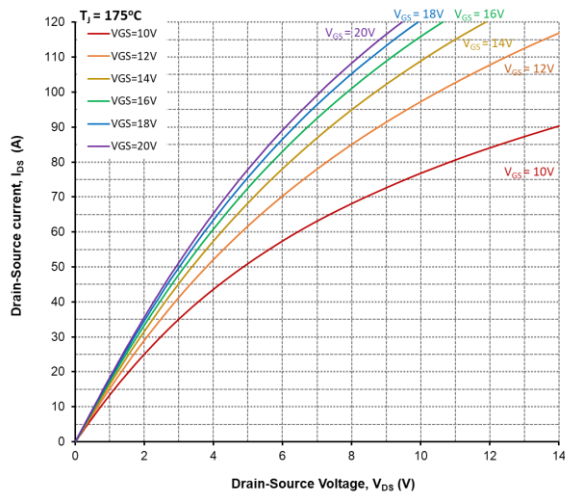

Figure 3. Output Characteristics, $T_J = 175^\circ\text{C}$

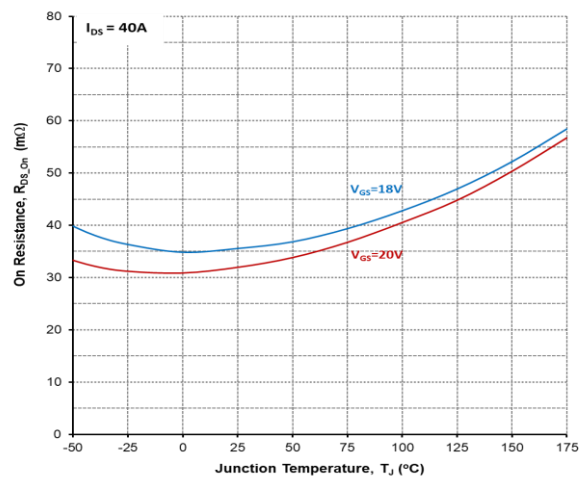

Figure 4. On-Resistance vs. Temperature

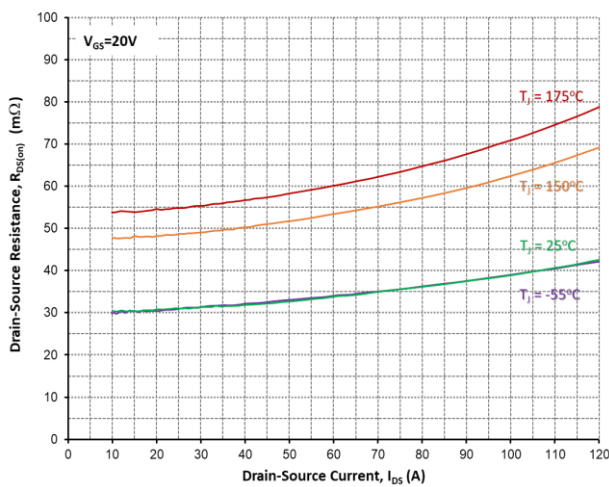

Figure 5. On-Resistance vs. Drain Current For Various Temperatures

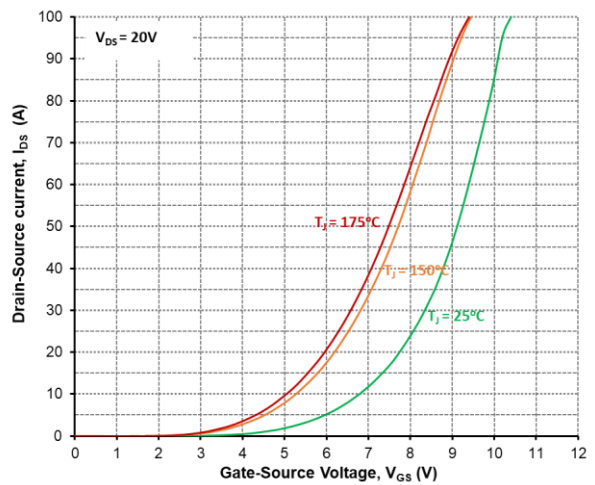

Figure 6. Transfer Characteristic For Various Junction Temperatures

Typical Performance

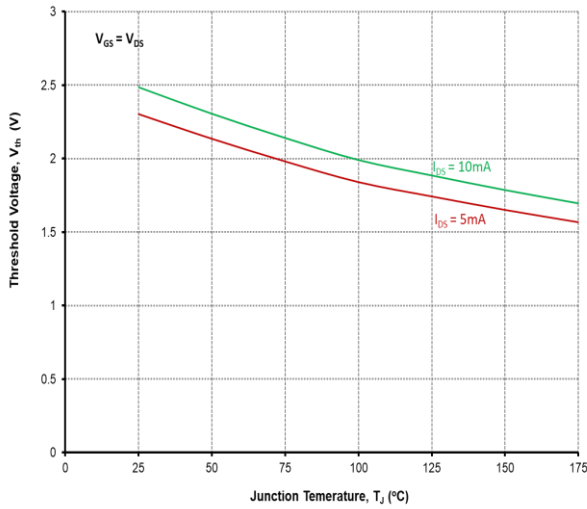

Figure 7. Threshold Voltage vs. Temperature

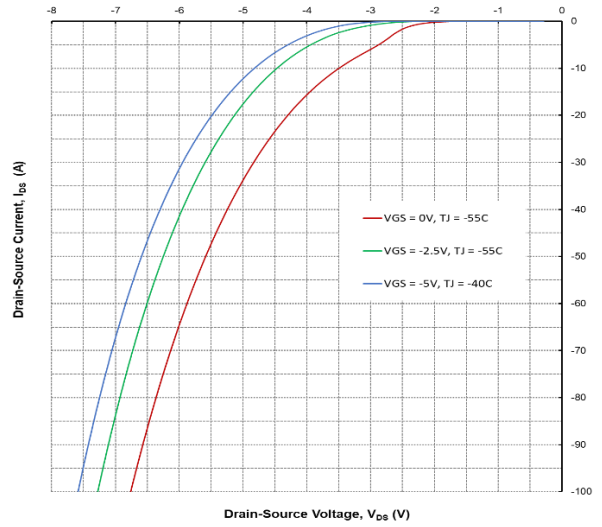

Figure 8. Body Diode Characteristics @ -55°C

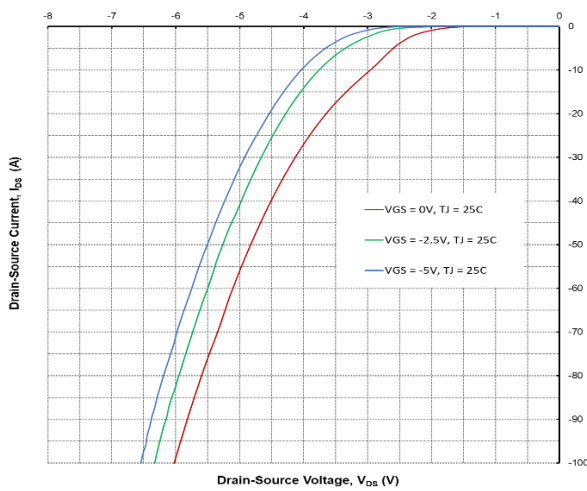

Figure 9. Body Diode Characteristics @ 25°C

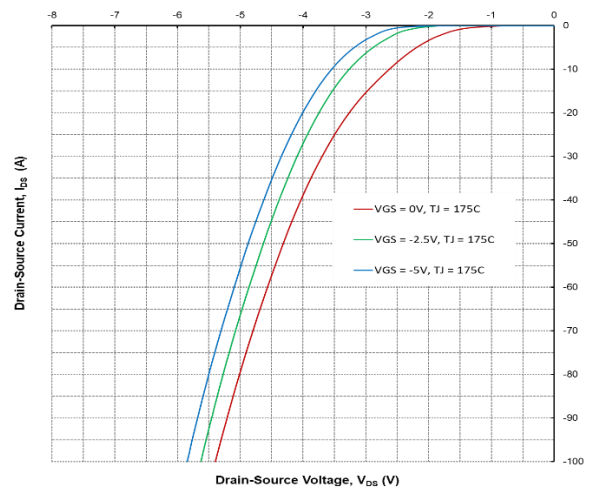

Figure 10. Body Diode Characteristics @ 175°C

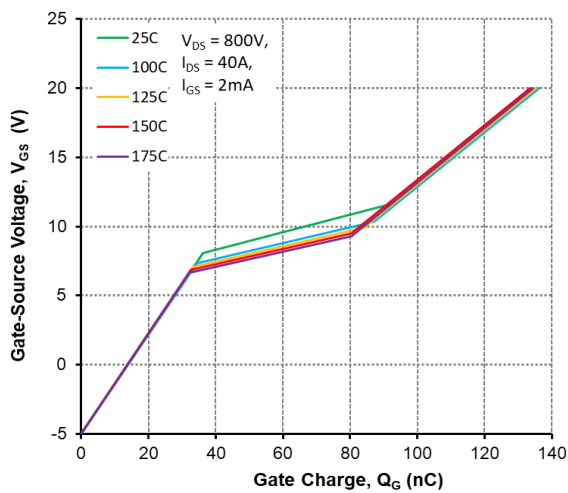

Figure 11. Gate Charge Characteristics

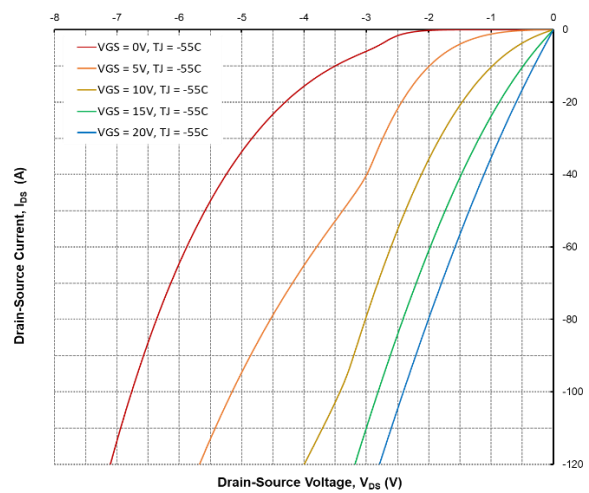

Figure 12. 3rd Quadrant Characteristics @ -55°C

Typical Performance

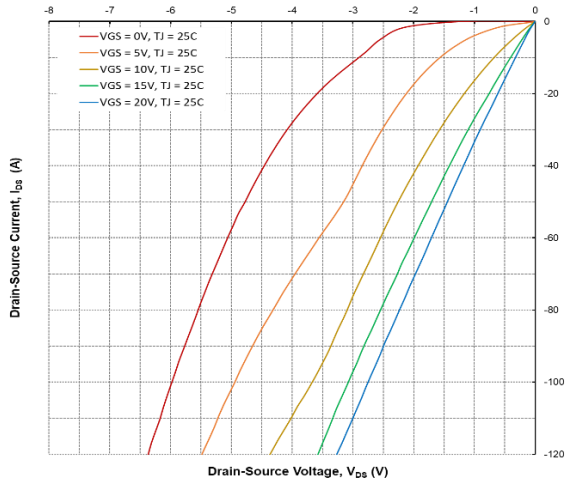

Figure 13. 3rd Quadrant Characteristics @ 25°C

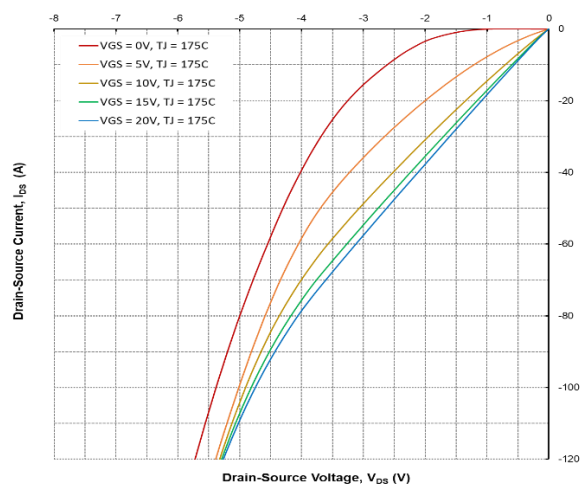

Figure 14. 3rd Quadrant Characteristics @ 175°C

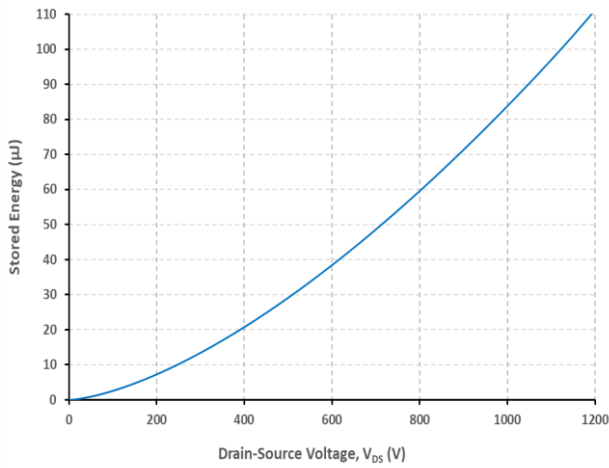

Figure 15. Output Capacitor Stored Energy

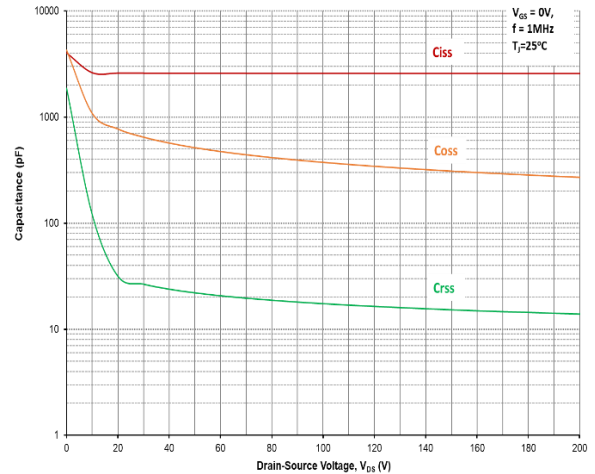

Figure 16. Capacitances vs. Drain-Source Voltage (0-200V)

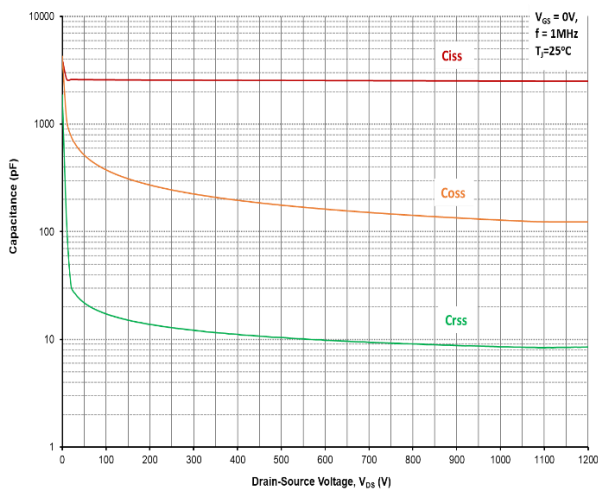

Figure 17. Capacitances vs. Drain-Source Voltage (0-1200V)

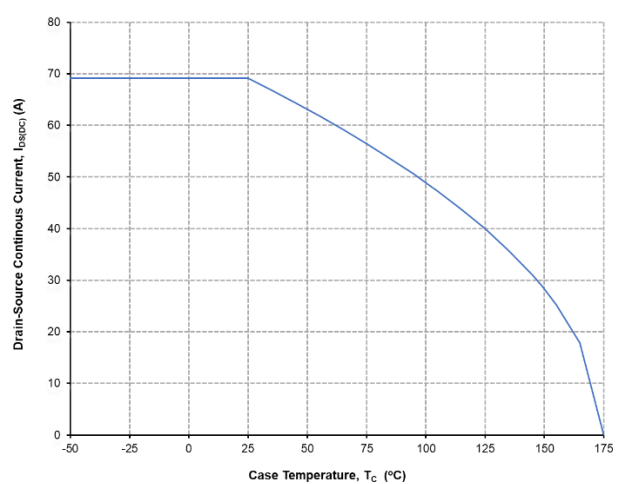

Figure 18. Continuous Drain Current Derating vs. Case Temperature

Typical Performance

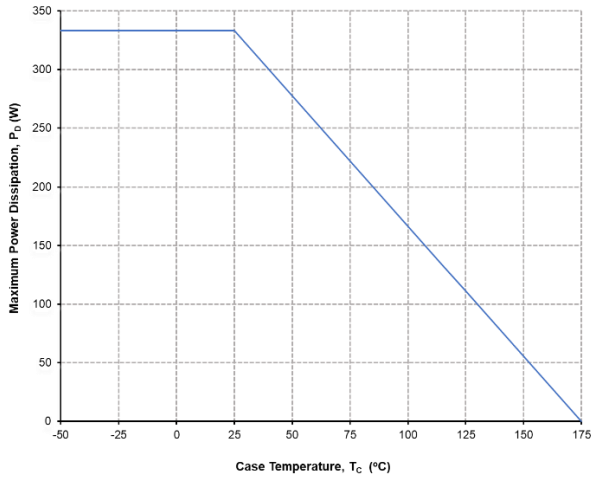

Figure 19. Maximum Power Dissipation Derating vs. Case Temperature

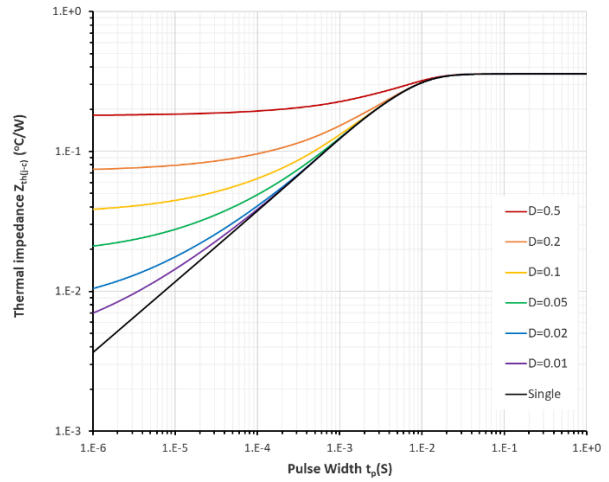

Figure 20. Transient Thermal Impedance (Junction to Case)

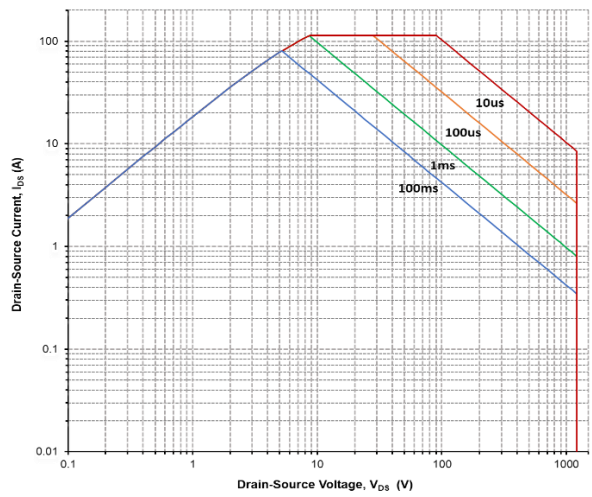

Figure 21. Safe Operating Area

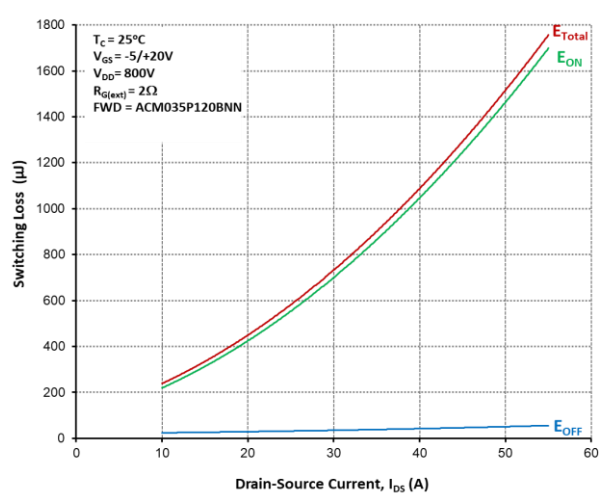

Figure 22. Switching energy vs Drain current

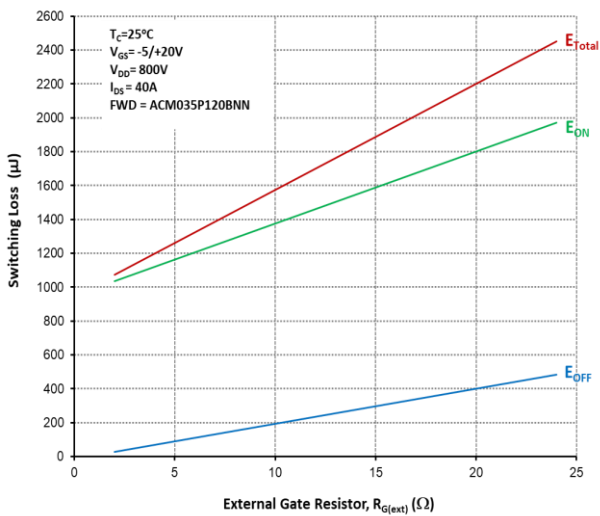

Figure 17. Switching energy vs External Gate Resistor

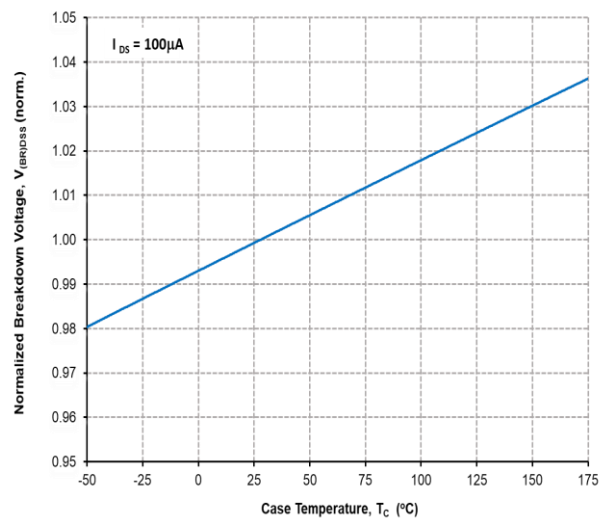
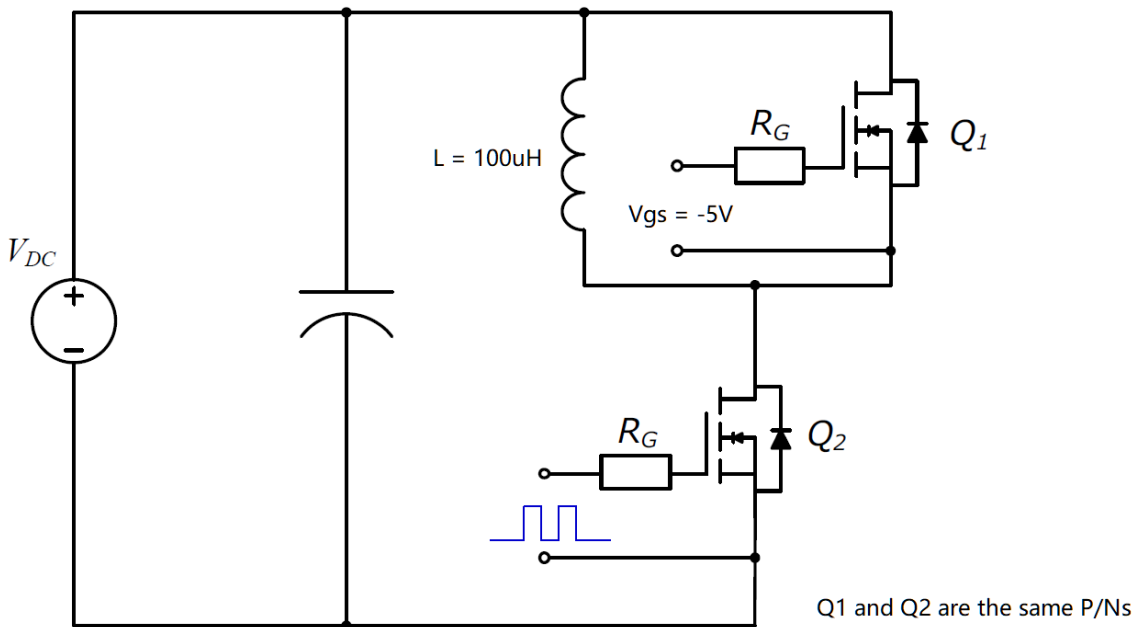
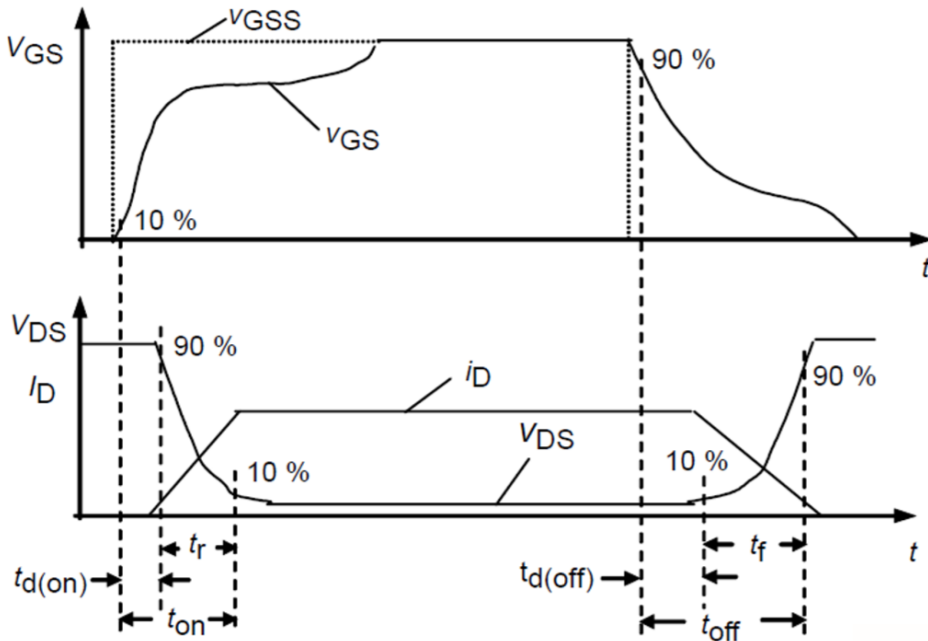

Figure 18. Normalized breakdown voltage vs Temperature

Switching Times Definition and Test Circuit



Package Dimensions

(TO-247-3 Package)

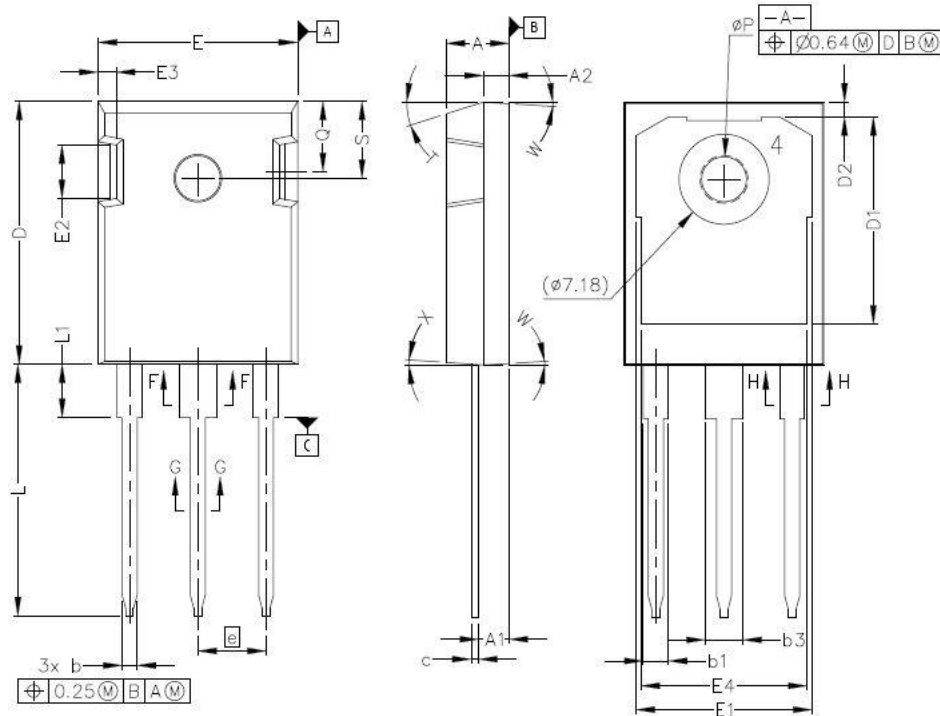

SYMBOL	MIN	MAX
A	4.83	5.21
A1	2.29	2.54
A2	1.91	2.16
b'	1.07	1.28
b	1.07	1.33
b1	1.91	2.41
b2	1.91	2.16
b3	2.87	3.38
b4	2.87	3.13
c'	0.55	0.65
c	0.55	0.68
D	20.80	21.10
D1	16.25	17.65
D2	0.95	1.25
E	15.75	16.13
E1	13.10	14.15
E2	3.68	5.10
E3	1.00	1.90
E4	12.38	13.43
e	5.44 BSC	
N	3	
L	19.81	20.32
L1	4.10	4.40
φP	3.51	3.65
Q	5.49	6.00
S	6.04	6.30
T	17.5° REF.	
W	3.5° REF.	
X	4° REF.	

NOTE:
1. ALL METAL SURFACES: TIN PLATED, EXCEPT AREA OF CUT
2. DIMENSIONING & TOLERANCEING CONFIRM TO ASME Y14.5M-1994.
3. ALL DIMENSIONS ARE IN MILLIMETERS. ANGLES ARE IN DEGREES.
4. THIS DRAWING WILL MEET ALL DIMENSIONS REQUIREMENT OF JEDEC outlines TO-247 AD.

- 1 - GATE
- 2 - DRAIN
- 3 - SOURCE
- 4 - DRAIN

